



## Triva TT OPERATION MANUAL

**WARNING!** BEFORE INSTALLING AND USING RIDEREVER PRODUCT IT IS CRITICAL TO YOUR SAFETY THAT YOU READ AND STRICTLY ADHERE TO THE INSTRUCTIONS IN THIS MANUAL. FAILURE TO DO SO COULD CAUSE SERIOUS INJURY AND/OR INVALIDATE YOUR LEGAL RIGHTS. KEEP THIS MANUAL IN A SAFE PLACE FOR FUTURE REFERENCE AS IT CONTAINS INFORMATION CRITICAL TO YOUR SAFETY.

**Note!** AS WITH ANY MANUAL, THIS ONE IS SUBJECT TO PERIODIC UPDATES. CONTACT YOUR MECHANIC, OR CHECK FOR UPDATES ON OUR WEBSITE, (www.riderever.com).

### IMPORTANT NOTICE

- Always seek help of a professional mechanic for mounting, disassembling, or adjusting the brake system. Any damage caused by improper assembly or follow-up maintenance will not be covered by the warranty.
- This manual provides information for mounting, using, and maintaining the braking system in a proper and safety ways. Follow manual procedures to ensure the best performance and operating life for your braking system.

**CAUTION!** Carefully follow SAFETY GUIDELINES for proper braking system function. This may affect the function of the brake.

**CAUTION!** Directs your attention toward unsafe practices which could result in damage to the equipment and injure yourself.

### SAFETY GUIDELINES

- For the best performance, follow the standard mounting procedures.
- Only use products recommended in this manual, to avoid system damage and potential danger.

02

- Never carry out any work or make any changes (e.g. disassembly, grinding/painting etc.) to your RIDEREVER product that are not specifically permitted and described in the manual.
- RIDEREVER braking devices offer a higher stopping power than normal brakes, wheels could be locked up with less effort. Practice several times before riding, to get used to the disc brake system. Be careful as a locked wheel can result in loss of control of the bicycle and can cause injuries.
- Wet weather impairs traction and braking force, making it much more difficult to control the bike. More attention must be paid while riding in wet conditions in order to avoid accidents.
- The required braking distance will be longer during wet weather. Reduce your speed and apply the brakes early and gently.
- Test the brakes and your braking technique on flat, even ground before using the bike in more severe conditions.
- The efficiency of the brakes depends on many factors other than brake system itself. These include the speed of the bike, wheel-terrain contact, brake lever application force, correct installation and maintenance, hydraulic brake fluid, levers, brake shoes or pads, condition of the bike, loading weight, correct braking technique, weather conditions, terrain spec., and so on.
- Always fit the spacer between brake pads when transporting bike with wheels off.
- Do NOT use brake pads supplied by other manufacturers. This will void your warranty. Only use original RIDEREVER products.
- Disc brakes have a burn-in period, and the braking force will gradually increase as the burn-in period progresses. Make sure that you are aware of any such increases in braking force when using the brakes during the burn-in period. The same thing will happen when the brake pads or disc brake rotor are replaced.

### WARNING!

- Brakes are essential for the safe use of a bicycle. The improper setup and usage can make you lose control and cause accident, with unpredictable consequences and potentially serious injuries.

03

- All RIDEREVER brake systems requires a break in (bedding in) period to obtain top performance. We recommend riding bike on a flat surface under speed of 15 km/h and braking it to speed 5 km/h for 20 times, then increase to a higher speed 30 km/h to brake another 20 times.

### BEFORE EACH RIDE

- Each pad should have a thickness of 0.5mm or more. Less than that is considered worn. Change it for your own safety.
- Front and rear brakes should work correctly with sufficient braking force.
- Make sure there are no fluid leaks in the system by applying the lever and holding it down as far as it will go. Check the hose connections and the brake fluid reservoir for any leaks. Consult a professional mechanic if there are fluid leaks, as it can cause a serious accident!
- The lever for rear brake is suggested to set on your habitual side, to ensure you a better stability during sudden brake. The wrong setting can cause rollover with serious injury. Have professional mechanic swap the lever position if they are incorrect.
- All fasteners should be tightened to the correct torque spec. Find related information (torque & tool) in the following operating instructions.

### WARNING!

- NEVER touch the caliper or rotor immediately after use, as disc brakes may get VERY HOT. Make sure the brakes have cooled down before any adjustment/maintenance.
- Never put your hand near or inside rotating parts. The disc brake rotor is sharp enough to inflict severe injury to your fingers if caught in the openings of moving discs.
- Be careful not to allow any oil or grease get onto the rotor or pad, otherwise the brakes may not work correctly. If any oil or grease gets on the pad, you should replace the pad. If any oil or grease gets on

04



the rotor, you should clean the rotor. If this is not done. The brakes may lose function.

### MINERAL OIL

#### CAUTION!

- Only use mineral brake fluid from a new bottle. NEVER use old fluid, or fluid that has been bled out of the system. Old fluid can contain water and this will compromise the performance and function of the system.
- Contact with eyes may result in irritation. In the event of eye contact, flush with fresh water and seek medical assistance immediately.
- Never use DOT brake fluid.

### BEFORE ASSEMBLY

#### CAUTION!

- When assembling the fasteners, always make sure they are tightened to the correct torque setting.
- Use a torque wrench provided with the required hex or TORX® inserts to install the fasteners.
- Never apply the lever without the pads in place or with the wheel removed. If this does happen, you will have to press the brake pads back into the caliper with a clean piston press tool.
- When installing new brake pads, be very careful to avoid contamination with oil or grease.
- Before each use make sure all the screws and bolts are tightened to the correct torque found in the manual.
- Must use a torque wrench to assemble the fasteners.
- Only correct mounting of the system and it's various support elements will ensure the safety of the cyclist and the exceptional performance of RIDEREVER disc brakes.
- Except bleed port screws, all screws require to apply medium strength threadlocker before assembly.

05

### ASSEMBLY

#### TOOLS REQUIRED

The following tools are necessary to install the RIDEREVER hydraulic disc brakes.

- T10 Torx screwdriver
- 1mm Allen wrench
- 2mm Allen wrench
- Torque wrench

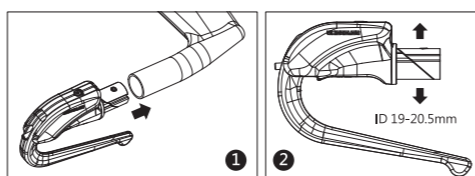

#### 1. BRAKE LEVER INSTALLATION

- Slide the brake lever onto the base bar (ID19-20.5mm), as shown in fig 1 &2 You may lightly tighten the clamping Screws by 2mm Hex key to hold the lever in place.
- Tighten the two brake lever clamp screws to 2-3Nm and check if any slipping.

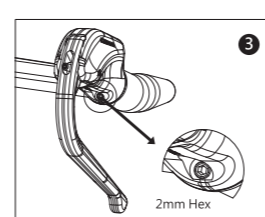

#### 1-1 Lever hose mounting

- Take out 1a from lever and remove 1b from hose
- Insert the hose 1c to 1d nut and make sure the hose is pushed to the end firmed(insertion safety depth must exceed the Installation marking line on hose, as shown in Fig 5
- Tight 1d nut by torque wrench with a torque setting at 8Nm After hose mounted.

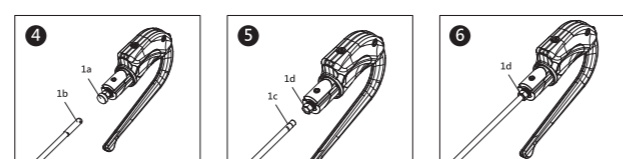

06

### 2. SEZ OPERATION MANUAL

#### A. Installation of SEZ-Fitting

- Remove the protective cap from oil housing.

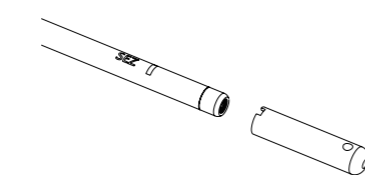

- Mount oil housing to the brake lever . Make sure the oil housing is pushed to the lever end firmed. (Insertion safety depth must exceed the installation marking line on housing, as shown in Fig. 1 & 2)

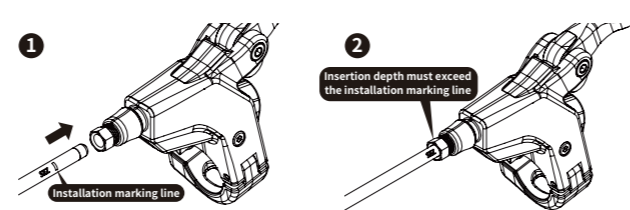

- Use 8mm wrench to tight screws while keep pushing the oil housing at the same time. Recommended tighten torque is 8Nm, as shown in Fig. 3.

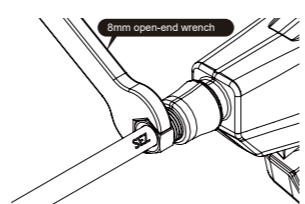

10

### 3. BRAKE SYSTEM BLEEDING

**WARNING!** Brake bleeding is one of the most important steps to ensure a perfect operation for hydraulic system. The presence of air inside the system reduces its performance.

#### RIDEREVER RECOMMENDS:

- Bleeding process should be performed by well trained mechanics. Do seek for professional helps.
- Use Elite/Pro JAGWIRE bleed kit.
- Use RIDEREVER or Finish Line™ Mineral Oil only.

If users lack of professional training decide to perform this operation by themselves, do follow these instructions with the maximum attention and consider that they are operating at their own risk.

- Fit the two syringes with assembled hose set (including 1. hose, 2. fitting, 3. front fitting, and 4. valve.

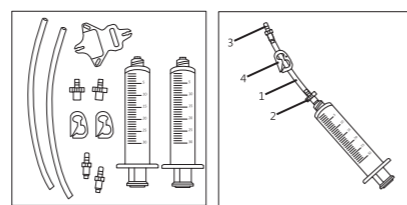

- Insert 15ml RIDEREVER Mineral oil in each syringe.
- Remove the brake caliper from the bicycle, unscrewing the proper screws as shown in the figure.
- Remove the caliper pads, see PAD REPLACEMENT, page 10.

14

### 2 YEARS LIMITED WARRANTY

This limited warranty is expressly limited to the repair or replacement of a defective product, at the option of RIDEREVER, and is the sole remedy of the warranty. This limited warranty applies only to the original purchaser of the RIDEREVER product and is not transferable. This warranty applies only to products purchased through an authorized dealer or distributor. The original purchasing receipt is required for claim applying.

This warranty does NOT cover the following:

- Damage due to improper assembly or follow-up maintenance or lack of skill, competence or experience of the user or assembler.
- Products that have been modified, neglected, used in competition or for commercial purposes, misused or abused, involved in accidents or anything other than normal use.
- Installation of components, parts or accessories not originally intended for or compatible with the RIDEREVER product.
- Natural wear and deterioration from normal use and aging.
- Man-made damage during bicycle assembly, include but not limit to remove, refit, or re-adjust on each parts.

In no event shall RIDEREVER be liable for any loss, inconvenience or damage, whether direct, incidental, consequential, or otherwise resulting from breach of any express or implied warranty or condition, of merchantability, fitness for a particular purpose, or otherwise with respect to our products except as set forth herein.

This limited warranty gives the consumer specific legal rights, and those rights and other rights may vary from place to place. This limited warranty does not affect your statutory rights. TO THE EXTENT NOT PROHIBITED BY LAW, THESE WARRANTIES ARE EXCLUSIVE AND THERE ARE NO OTHER EXPRESS OR IMPLIED WARRANTIES OR CONDITIONS INCLUDING WARRANTIES OR CONDITIONS OF MERCHANTABILITY AND FITNESS FOR A PARTICULAR PURPOSE.

18

### 2. CALIPER INSTALLATION

- Caliper should mount on the frame or fork with no interference.
- All screw sets should have washer assembled, and medium strength threadlocker applied. (Pair washers should pay attention to the concave & convex fitting)

#### 2-1 FLAT MOUNT TYPE

##### 2-1-1 Front wheel

- Attach caliper on RIDEREVER FF-1 adapter in correct direction (for 140 or 160mm rotor). Tighten screws M5\*13 x 2pcs by T25 Torx wrench on torque 5~7Nm.
- Assembly adapter on fork with washer attached screws M5\*14.7 x 2pcs by T25 Torx wrench. (don't completely tighten)
- Slightly loosen screws, pull brake lever 2-3 times to align caliper and rotor.
- Keep the brake lever pulled and tighten the screw sets on torque 5~7Nm.

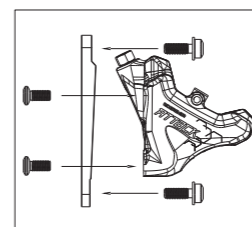

##### 2-1-2 Rear wheel

- Choose screws which is 6~8mm longer than the mounting hole, with washer and medium strength threadlocker applied (Insert screw into mounting hole, check if protruding length meets this standard.)
- Caliper assembly:
  - For 140 rotor (without adapter):
    - Assembly caliper on frame with chosen screws (washer attached) by T25 Torx wrench. (don't completely tighten)
  - For 160 rotor (with adapter):
    - Attach caliper on RIDEREVER FF-2 adapter with "UP" faces front, tighten screws M5 \* 13 x 2pcs by T25 Torx wrench on

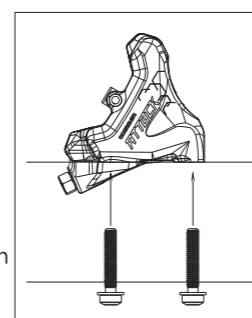

07

- Remove the spacer from lever , as shown in Fig. 4 to completed the housing installation.

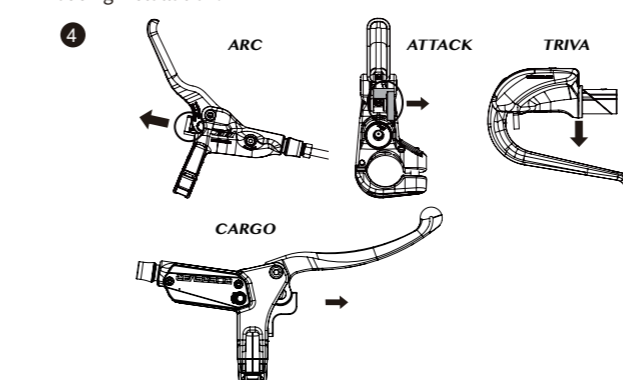

#### B. Cutting and installation of SEZ fitting

If you need to adjust and cut oil housing before insert the housing to lever, please refer to the following steps.

- Remove the protective cap from oil housing(as shown in A)
- Use housing cutter cut to preferred length. (Please make sure that the incision is flat and smooth. It may result in oil leakage if the incision is askew)
- Must re-measured and re-mark the installation marking line 14mm from the cut surface on the housing after cutting, as shown in Fig. 5.
- Pre-mount the new pin(SM-B003) to housing first
- Use needle driver, insert new needle into the oil housing . (Please make sure the needle surface is flush with oil housing surface after installation)

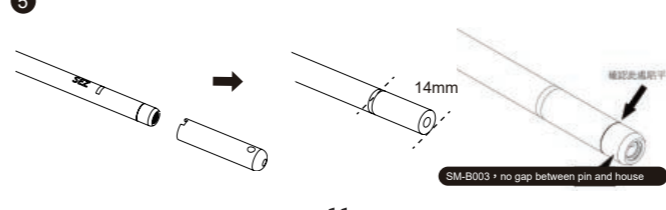

11

- Insert the suitable RIDEREVER bleed block in the caliper unit, as shown in the figure.

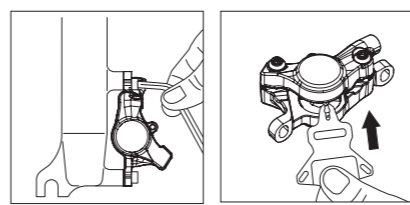

- Remove caliper bleed port screw, and thread in the syringe CS (Caliper Syringe)

#### 4. Bleeding to brake lever

- Use T10 Torx screwdriver to remove brake lever bleed port screw 5a, and thread in the syring LS(Lever Syringe)

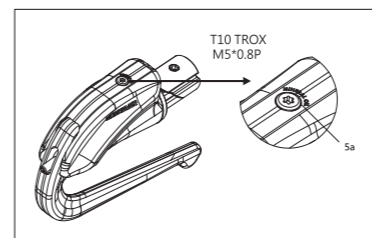

- Align syringe & bleed port to an upright position, to ensure air bubble have clear way out.
- Press CS & pull LS, leading air bubbles out of the system while oil circulates.
- When CS syringe oil level is 5ml, revert the operation (Press LS & pull CS).
- Do keep 5ml oil for both CS and LS throughout the whole operation, and ensure that no air bubbles enter the system again.

15

#### C. Cutting after housing installation

Once you completed the installation of the oil housing, if you still need to cut oil housing, please refer to the following steps.

- use 8mm wrench tool, untighten nut completely, then take out the housing As shown in fig 6. You will see the pin and bushing attached with housing as shown in fig 7.



- Use housing cutter, cut the hose to proper length you need. (Please make sure the incision is flat and smooth. It may result in leaking if the incision is askew)
- must re-measure and re-mark the installation marking line 14mm from the cut surface on the housing after cutting, as shown in Fig. 5

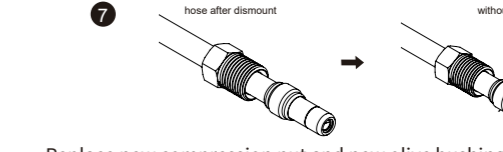

- Replace new compression nut and new olive bushing into the hose in order, as shown in Fig. 8.

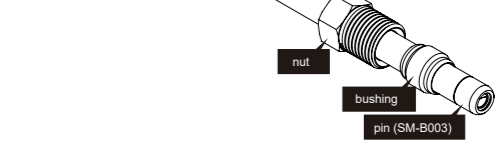

- Pre-mount the new pin(SM-B003) to housing first
- Use needle driver, insert new needle into the oil housing . (Please make sure the needle surface is flush with oil housing surface after installation)
- Pre-mount the new pin(SM-B003) to housing first
- Follow steps of A 1-A3 for housing installation.

12

### Function inspection

It is possible that air enters system during the installation. Inspection must be done before riding. Make sure that brake function works normally. In order to keep brake preformation as normal after hose cutting, please re-bleeding mineral oil and exhaust air to complete the installation. Please refer to step of "Operation for air exhaust process" in the RIDEREVER user manual.

Please refer to "Function inspection manual" to ensure that brake function works normally after installation.

- Make sure the brake is either installed with rotor correctly on the frame or check if the block spacer is still in the caliper before inspection.
- Remove the lever block spacer.
- Press brake lever repeatedly for 10~15 times. Make sure the brake feeling is strong during pressing and the brake lever will not touch the handlebar. If it feels soft or the brake lever touch the handlebar without braking performance, please rebleeding oil and exhaust air (refer to the step of " Operation for air exhaust process" in the RIDEREVER user manual).

#### ⚠ Attention !

- Must use required torque wrench and recommended tighten torque force in installation. Improper installation may cause the oil housing falling out during riding and in result of serious consequences to users and riders.
- If the oil housing is too short , the oil housing may be falling out from brake lever or caliper in riding due to over extension. The proper housing length must be decided before cutting.
- Please don't reuse olive bushing and insert needle. Used olive bushing and insert needle maybe deformed after tighten. It's not guarantee that the used olive bushing and insert needle can connect the lever or caliper firmly. Please use new spare parts.
- Please must to rebleeding mineral oil and exhaust air after housing cutting.
- The block spacer is assembled to avoid press by mistake but do not press the brake lever before complete installation of oil housing; otherwise it could lead to oil leaking.
- Remove the Lever block spacer after completed installation of oil housing.
- It is strongly recommended to use original RIDEREVER spare parts for oil housing to have completest function of RIDEREVER product.

13

- Remove RIDEREVER spacer from the caliper unit as shown in the figure.
- Install the brake pads in the caliper, see PAD REPLACEMENT, page 9.
- Fit the caliper on the bicycle, see ASSEMBLY, Page 7.

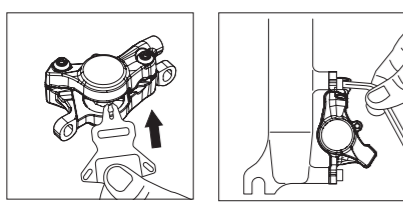

17

- Repeat this operation for at least 3~4 times until the air bubbles have completely flown out and collected in the syringes (when there is no more air in the system, syringe operation becomes harder)
- Press brake lever and release it slowly while pressing CS. This helps oil flowing for the final check.
- Circulate the oil from CS to LS 2-3 times to confirm there are no air bubble remaining.
- Slightly press on both syringes at the same time to fill the system. (try to keep CS side at the lowest level 5ml in the end.)
- Lock valve 4 on the CS, then remove CS from caliper.
- Tightening caliper bleed port screw by with a torque of 2 Nm±5%.
- Immediately clean any oil leaks using a clean fabric and isopropyl alcohol.

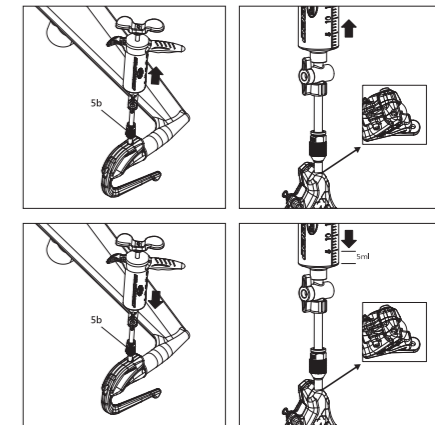

- Press brake lever and release it slowly while pressing LS. Repeat it several times, to ensure oil filling in the system.
- Lock valve 4 on the LS, then remove LS from brake lever.
- Tightening brake lever bleed port screw 5a with a torque of 2 Nm±5%.
- Immediately clean any oil leaks using a clean cloth and isopropyl alcohol.

16